

K-BUS[®] IR Emitter & IR Learner

User manual-Ver. 2.2

BTIS-04/00.1

BTIS-01/00.1

BTIL-01/00.2

KNX/EIB Intelligent Installation Systems

Version to upgrade (Required)

Version	Upgrade Instructions	Date
User manual-Ver2	After upgrading the software on the user interface with a legacy of great changes, in order to better use the upgraded software, it is recommended for the first time using this software users read the manual.	2013/12/12
User manual-Ver2.1	The main changes are as follows: 1 Description of the type 4bit Function(See 3.3.6); 2 The demo of IR transmitter (See 4.4.2); 3 Description of the current detection(See 3.3.4), Note: Function not implemented.	2014/05/26
User manual-Ver2.2	The main changes are as follows: 1. Since 4bit is not supported, the description of the 4-bit data type is deleted; 2. Deleted the relevant description of current detection; 3. The arrangement of the chapter contents was adjusted, and the technical data, circuit diagrams and dimension diagram of the product had been added. The title of the manual was changed to IR Emitter & IR Learner from IR Configuration Tool.	2018/11/02

Contents

1. General	5
2. Technical data	6
2.1 The IR Learner	6
2.2 The PC Software	6
2.3 The IR Emitter (BTIS-04/00.1)	7
2.4 The IR Emitter (BTIS-01/00.1)	8
3. Dimension and Circuit diagram	9
3.1 Dimension diagram	9
3.2 Circuit diagram	10
4. Software Introduction	12
4.1 Software Interface	12
4.2 Main menu	12
4.2.1 [File]	12
4.2.2 [View]	13
4.2.3 [Help]	13
4.2.4 [语言(Language)]	14
4.3 Debug Window	14
4.3.1 Information input	15
4.3.2 Information display	16
4.4 IR configuration	17
4.4.1 Device manager	17
4.4.2 IR learning Code manager	17
4.4.3 Appliance function detailed list	18
4.4.4 The device command configuration box	18
4.4.5 Device command library	19
4.4.6 Group configuration	19
4.5 The download window	20
4.6 Error list	21
5. Demo	22
5.1 Communication settings	22
5.2 IR configuration function	23
5.2.1 New Controlled appliance	23
5.2.2 New IR transmitter	26
5.2.3 Error correction	29
5.2.4 Download	29

5.2.5 Debug-----	29
5.2.6 Import\Export IR learning encoding data-----	29
5.3 Security settings-----	31
5.3.1 Encryption-----	31
5.3.2 Change Password-----	31
5.4 The language switching-----	31
5.5 Precautions-----	32
6. Appendix 1 Device Command execution process-----	33
7. Appendix 2 The response process of IR Emitter receiving the group telegram-----	35

1. General

We call it “IR Learning” that combine the three parts, PC Software, IR Learner and IR Emitter. The IR Learning can be used for learning control code of the IR Remote Controller, and storing the code to the database in the PC software. The learned control code can be stored, deleted or tested in the software.

The IR Emitter has BTIS-04/00.1 and BTIS-01/00.1. The BTIS-04/00.1 has 4 channels. Usually, we use one channel to control one IR Remote Control device. The IR Learning can learn up to 64 functional control codes for each channel. However, the BTIS-01/00.1 supports 360 degree full direction transmitting, and support up to 256 IR codes control.

The IR Learning is consist of PC Software, IR Learner and IR Emitter.

The PC Software is used for config the functions, like physical address, group address, scene call, etc.

IR Learner is connected to the PC via USB interface and used to learn the control codes of the keys of the IR Remote Controller. The learning process is realized by operating the software, and you should put the IR emitter on the remote control near to IR detector on the IR Learner as close as you can to avoid the failure of learning.

The IR Emitter is connected to the EIB/KNX bus directly using the EIB bus connection terminal. As the configuration has been finished, the PC software can download the learned control code to the IR Emitter via the KNX downloader, which has been connected to the KNX/EIB bus. After success to download, the IR Emitter can control the switch, wind speed and timing of a fan, as well as the IR remote control devices, such as DVD, TV, Air-Condition, Fan, etc. through sending telegrams on the KNX bus by other devices in the EIB/KNX system.

This manual provides detailed technical information about the IR Learning for users as well as assembly and programming details, and explains how to use the IR Learning by the application examples.

The functions of the IR Learning are summarized as follows:

- ◆ Supports the IR Emitter of BTIS-04/00.1 and BTIS-01/00.1 versions ;
- ◆ The device manager of IR can be configured with 20 IR Emitter devices at most ;
- ◆ The device manager of IR Learning code can be configured with 40 controlled appliances ;
- ◆ Each of the controlled appliance can learn 40 key encoding at most ;
- ◆ Each devices have 4 channels, and can configure 256 commands ; (maybe the BTIS-01/00.1 can support more devices, but max. number of commands still are 256)

- ◆ Each channel can be configured with 16 group addresses at most ;
- ◆ To learn more than 95% of remote controller in the market ;
- ◆ The IR control commands can be assigned to 2 types of object(1bit 1byte), 1bit object can recall the IR control commands of the devices, but 1byte object only can recall the corresponding IR control commands of channel through the scene mode;
- ◆ Sending time and sending delay can be set for per IR commands ;
- ◆ Each command can include 5 slave functions, this way is suitable for controlling several functions via one command at a time ;

2. Technical data

2.1 The IR Learner

The IR Learner uses a common USB port to communicate, it is easy to learn the functional control codes of the IR remote controller and store the codes to the database of the PC Software

The design of the IR Learner is as a UDisk, small and exquisite in size. The IR Learner is needed to use only when it learns the functional control codes of the IR remote controller.

Attention: When learning, please put the IR emitter on the remote control near to IR detector on the IR Learner as close as you can(within 3cm) to avoid the failure of learning.

The IR Learner is provided with receiving and emitting IR function, so it can test and verify whether the learned control code has been learned correctly.

For convenient to operate, suggest that connect the IR Learner to PC via a USB extension cord please.

2.2 The PC Software

K-BUS Tool is PC configuration software to configure some devices from video-star, below describes the overall framework of the software and the use of IR configuration function. The IR configuration function of this software are only available in conjunction with the IR Learner and IR Emitter. In addition, the software also provides configuration debugging capabilities, you can avoid ETS software configure device debugging steps , greatly improve the work efficiency.

The Debug function are summarized as follows:

- ◆ Used to send the message of group address and monitor the group address message on the

bus.

- ◆ Only support to send a type of 1bit , 1byte message;
- ◆ Support group address message series [write] cycle transmission;
- ◆ Support group address message series [read] cycle transmission;
- ◆ Support the manual transmission of group address message;
- ◆ Can store 10 different message series;
- ◆ Each series can add 150 test data (including the delay and group address message).

Operating system: the operating system version of Windows XP(32bit) Windows 7(32/64bit) and Windows 8;

Operating environment: must install "FalconRuntime v2.2.msi" run time library on the PC .

2.3 The IR Emitter (BTIS-04/00.1)

The extremely compact design enables the IR Emitter to be inserted into a conventional 60 mm or 86mm wiring box.

Attention: the Infrared emitter of the IR Emitter must be installed in range that the IR device can detect normally, to avoid no action.

Power supply	Bus voltage	21~30V DC, via the EIB bus
	Standby current	<8mA
	Dynamic current	<20mA
	Power consumption	<240mW
Output	Channel Number	4 Channels
	Max. transmitting distance	2m
	IR wavelength	940nm
	IR emission&receiving angle	<45°
Operating and display	Red LED and button	For assignment of the physical address
	Green LED flashing	Indicate the device running normally (OK)
Connections	EIB/KNX	Bus connecting terminal (black/red)
	Infrared emitter cable	<10m
Temperature	Operation	- 5 °C ... 45 °C

GVS	K-BUS [®]	KNX/EIB	K-BUS Tool
range	Storage		-25 °C ... 55 °C
	Transport		-25 °C ... 70 °C
Mounting	Flush mounted	In wiring box, 60mm×60mm or 86mm×86mm	
Dimensions	the IR Emitter	46mm×46mm×11.7mm	
	the IR Learner	52.5 mm×18.1mm×9.3mm	
Weight	0.05kg		

2.4 The IR Emitter (BTIS-01/00.1)

Power supply	Bus voltage	21-30V DC, via the EIB
	Current consumption	Max. 12mA
	Power consumption	Max. 360mW
Auxiliary Power	Work voltage	12-30V DC
	Auxiliary current	<200mA
	Auxiliary power consumption	<6W
Output	Infrared wave	940nm
	Distance	radius: 4m~5m
Installation	Mounting	Height Max.4m
Connections	EIB/KNX	Via bus connecting terminal
Operation and display	Red LED and push button	For assigning the physical address
	Green LED flashing	For displaying application layer running normally
Temperature	Operation	-5 °C ... + 45 °C
	Storage	-25 °C ... + 55 °C
	Transport	-25 °C ... + 70 °C
Environmental	humidity	<93%,except condensation

3. Dimension and Circuit diagram

3.1 Dimension diagram

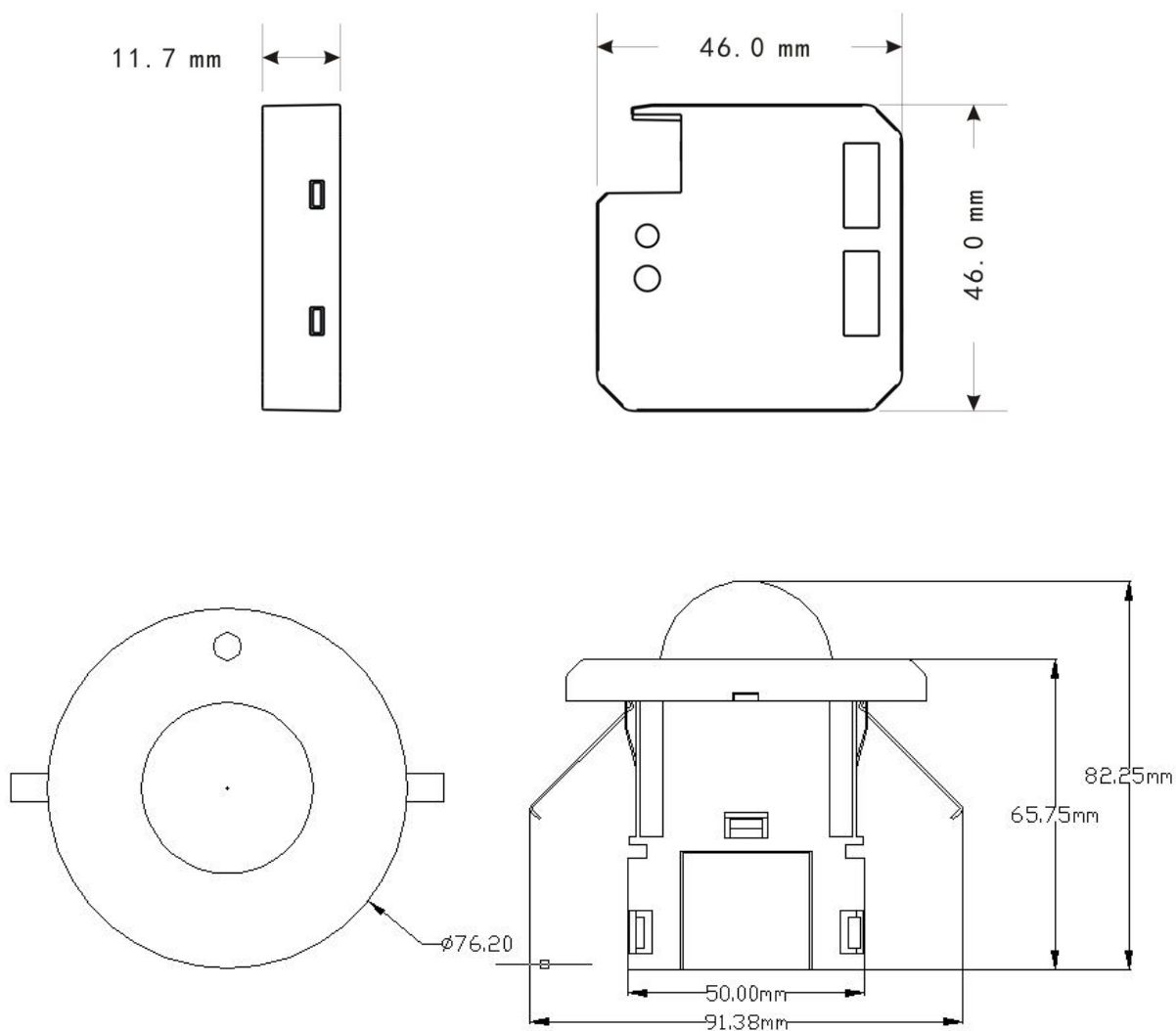

3.2 Circuit diagram

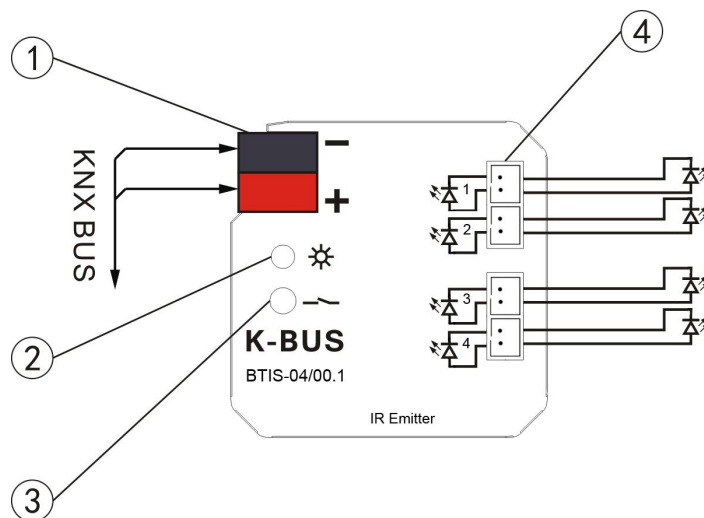

Fig.(1) IR Emitter (BTIS-04/00.1)

- ① KNX / EIB bus terminal
- ② Red LED for entering the physical address, green LED for application layer normally work
- ③ Programming button
- ④ Connectors for Infrared emitter cable



Fig. (2) IR Learner (BTIL-01/00.2)

- ① USB communication port
- ② IR detector. When learning, please put the IR emitter on the remote control near to IR detector on the IR Learner as close as you can

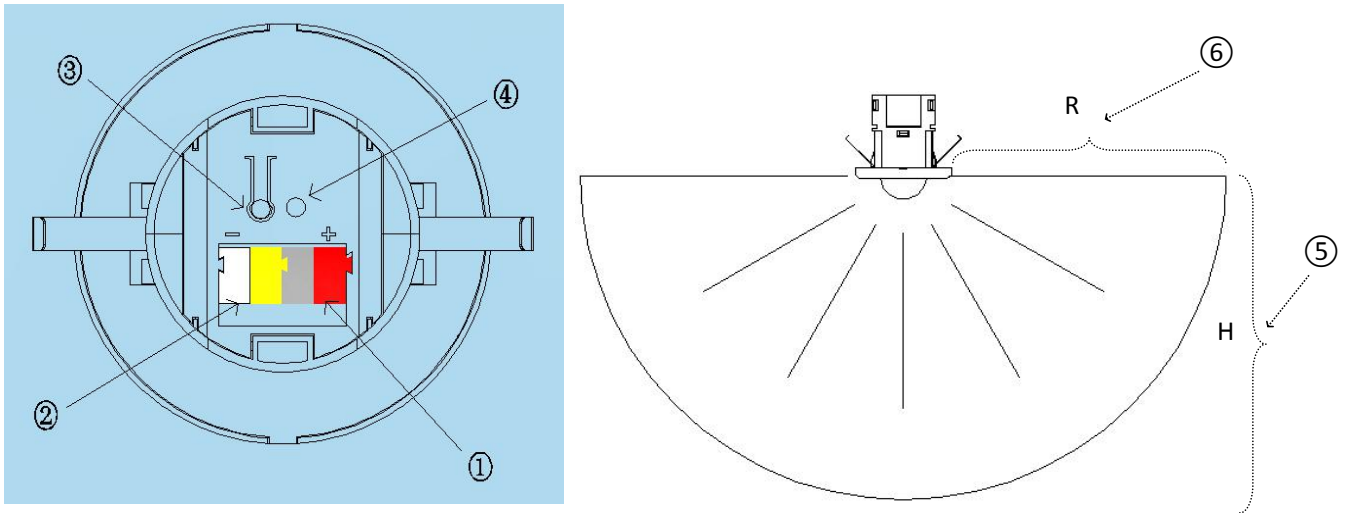

- ① KNX / EIB bus connection terminal
- ② Auxiliary power supply connection terminal
- ③ Programming push button
- ④ Programming LED, red LED light up for assignment of physical address,
Green LED flashes for indicator of the device running normally
- ⑤ Installation height : Max.4m
- ⑥ Transmit radius: 4m~5m

4. Software Introduction

The software supports two language: Chinese and English,when under the English operating system want to normal use Chinese interface, you need to install Chinese language pack .

4.1 Software Interface

Double-click the shortcut on the desktop [K-BUS Tool.exe] or select [Start]/[All Programs]/[K-BUS Tool]/[K-BUS Tool.exe] to start the software,the initial interface shown as in fig. 4.1.

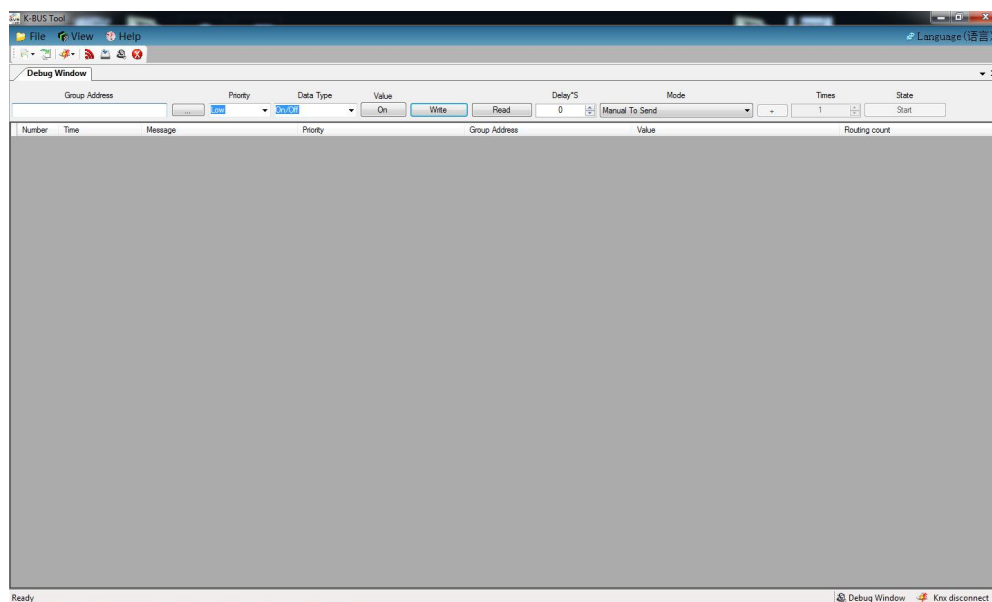

Fig.4.1 The initial interface

4.2 Main menu

The main menu include three menu group: [file] [view] [help], these menu group content and method of use will introduce as follow section.

4.2.1 [File]

The drop-down menu shown as fig.4.2.

- ① [New]: Create a new configuration file;
- ② [Open]: Open the configuration file;

- ③ [Security settings]:Set password of current configuration file;
- ④ [Communication]:Software and KNX bus communication settings;
- ⑤ [Recent files]:Browse or open the 10 recent success opened files;
- ⑥ [Quit]:Exit the software.

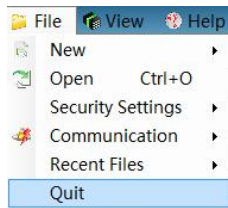

Fig.4.2 [File] drop-down menu

4.2.2 [View]

The drop-down menu shown as fig.4.3.

- ① [IR Configuration]:Show IR Configuration window;
- ② [Download]:Show Download window;
- ③ [Error list]:Show Error list window;
- ④ [Debug]:Show Debug window;
- ⑤ [Toolbar]:Show Toolbar.

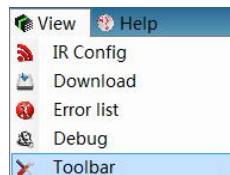

Fig.4.3 [View] drop-down menu

4.2.3 [Help]

The drop-down menu shown as fig.4.4.

- ① [About]:Show the software version number information;
- ② [User manual]:Open the user manual.

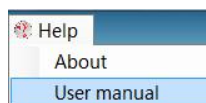

Fig.4.4 [Help] drop-down menu

4.2.4 [语言(Language)]

The drop-down menu shown as fig.4.5.

- ①[Similified Chinese]:Select simplified Chinese as the software display language next times;
- ②[English]:Select simplified English as the software display language next times.

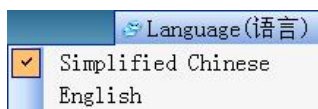

Fig.4.5 [语言(Language)] drop-down menu

4.3 Debug Window

The debug window shown as fig.4.6,it is similar to ETS4's "Group Monitoring" window,but the functions of debug window would be far less than the functions of ETS's "Group Monitoring", therefore,to obtain more detailed information we need to use the ETS4 "Group Monitoring" window for the test.Debugging is mainly to write or read the device's group data by sending a group telegram, then the user according to the feedback information and the response of controlled appliances to judge the downloaded in the device configuration is in force or not.

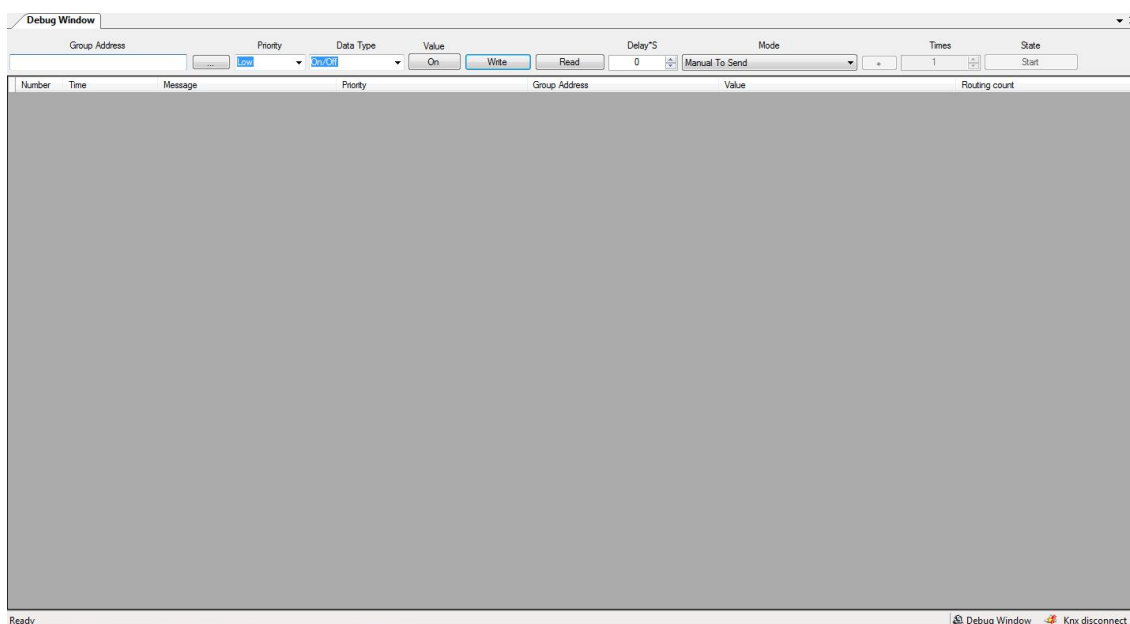

Fig.4.6 Debug Window

The debug window includes information input box (fig.4.6 the gray background area) and information feedback box(fig.4.6 the dark background area).These informations are described in the following subsections.

4.3.1 Information input

There are two kinds of group telegram sending mode [manually send, circular sent (write / read)] in the information input box:

①Manual to send:

Group address: The group address of mailing telegram ;

Priority:The priority of sending Group telegram on the bus;

Button "...": Browse all input record of the group address;

Data type:The data type of group telegram ;

Value: The value of group telegram ;

Button "Write": To send the telegram which write group information;

Button "Read": To send the telegram which read group information;

Delay: Delay time of telegram sending after click the button "write/read".

②Circular sent (write / read)

(1)Loop to write

Times: The sending times of group address telegram series;

Button "+": Pop up a dialog box of adding group address series(Shown as fig.4.7).

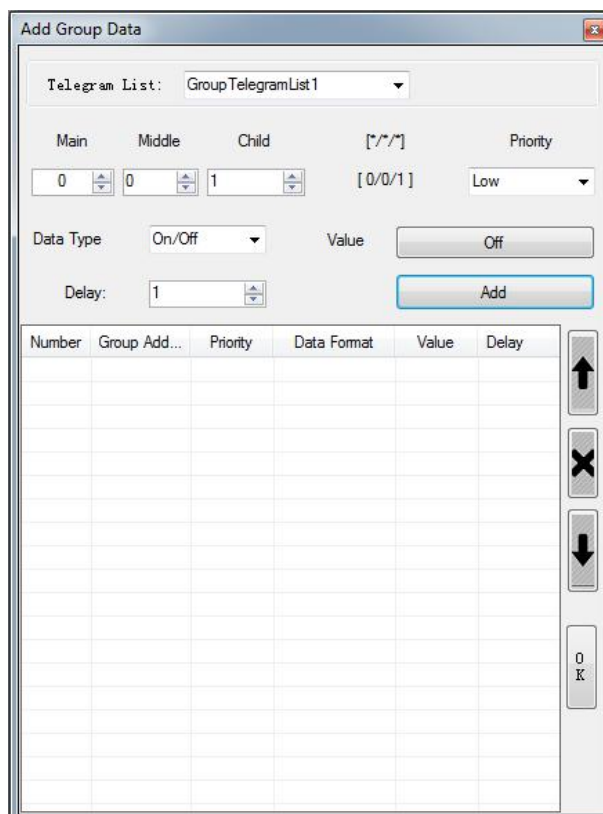

Fig.4.7 Group list dialog box-write

Through the dialog can add and save 10 cycling test series,each series can add 150 group telegram.When the cycling send start, the debug window will according to the telegram which was stored by the current test sequence, and according to the serial number in turn send the telegram.

(2)Loop to read

Times: The sending times of group address telegram series;

Button "+": Pop up a dialog box of adding group address series(Shown as fig.4.8,details please see page [Loop to write](#)).

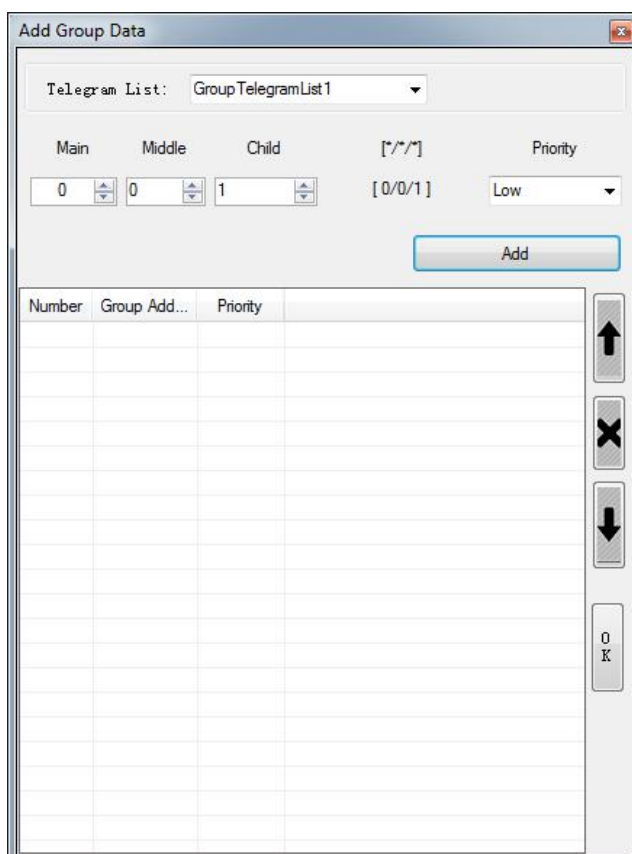

Fig.4.8 Group list dialog box-Read

4.3.2 Information display

Number:The sequence number of Feedback message ;

Time:The time of detecting message ;

Message: The information of feedback message;

Priority: The Priority of telegram ;

Group address: The group address of telegram ;

Value: the value of telegram ;

Rount count:The routing count of telegram .

4.4 IR configuration

IR configuration window is used to configure the function of IR Emitter, the contents of the window as shown in fig.4.9. Through IR Learning Code Manager, we can learn and record each IR encoding of the appliance remote controller's function, and can config the key function encoding into the commands library by the commands configuration box, according to a certain format configured to the command which IR Emitter can call, then through the group configuration box you can config the group address of channel function, the command to call and so on. Finally downloaded the configuration to the IR Emitter via the KNX Bus.

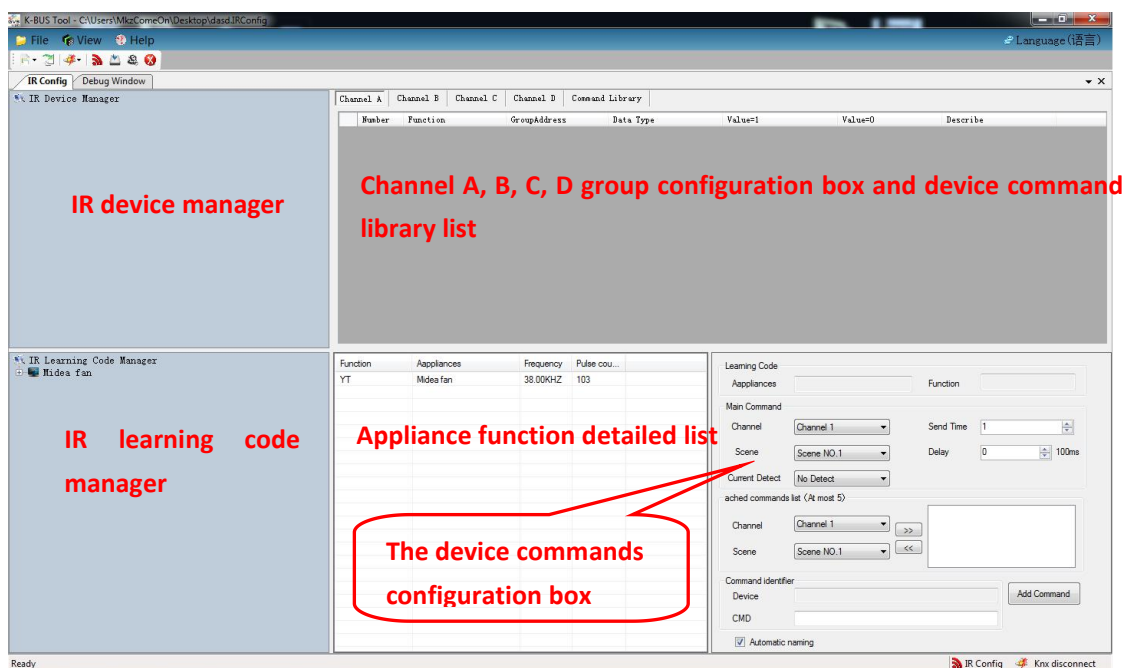

fig. 4.9 IR Configuration

4.4.1 Device manager

The device manager is a mechanism to manage the configured information of IR Emitter, it is mainly used for device of new, delete, modify the properties, channel selection, download of the configured information.

4.4.2 IR learning Code manager

IR learning Code Manager is a mechanism to manage the information of the controlled appliances which have IR remote controlled function, it is mainly used for the controlled electrical new, delete, rename, import or export IR learning code, and the remote controlled function of

appliance's new and learning, test.

4.4.3 Appliance function detailed list

The appliance function detailed list is used to display the item sub information which are selected by the learning code manager. we can check the appliance name of selected items, electrical function, the frequency and pulse counting of the electrical function remote controller, also can pass the test to verify the effectiveness of learning code.

4.4.4 The device command configuration box

Device command box is divided into four parts: learning code, the main command, the list of Attached commands and command marks.

① Learning Code (Choice in the appliance function detailed list)

Appliance: The electrical which the main command calls the electrical function;

Appliance function: the main command calls the electrical function;

② Main command

Channel: Part of a command;

Scene: Part of a command;

Send time: The number of send command, for example, the wind speed function of a fan is set to 2 times for transmitting, then when the transmitter receives a corresponding telegram, the transmitter will send the wind speed signal to the fan and continuous send 2 times, then the wind speed of the fan will jump 2 steps.

Send delay: To set the send delay for the command. For example, you turn on a fan, and attach a pivot and time function. If they are executed at the same time, this may influence the life of the fan motor, so you can delay a period of time for transmitting of the pivot and time function. Then when the transmitter receives a 14 corresponding telegram, the transmitter will first send the open function signal to the fan, after a while send the pivot function signal to the fan, and then after a time send the time function signal to the fan, in order to protect the motor of the fan.

③ the list of from commands

Channel: Part of a command;

The scene: Part of a command;

Button ">>": Add a from command;

Button "<<": Delete the from command of selected.

④Command marks.

Device: The device of the current configuration command;

Command: The mark of current command;

Button "Add command" or "Modify command" : Add new command or modify the old command;

"Automatic naming" : Selected whether or not automate name for the device command.

4.4.5 Device command library

Select the tab [Command Library] in the red box of group configuration shown in Figure 4.10 the detailed list of device command Library. The detailed list of device command library shows all the commands' parameters which are configured for the device by the user, Its main parameters had detail introduced in the previous subsection, so this section do not introduce anymore.

Number	CMD	Main Command Parameters			Attached CMD	Send Times	Delay(100ms)	Current Detect
		CMD Number	Appliances	Function				

Fig.4.10 The detailed list of device command Library

4.4.6 Group configuration

In the group configuration, users can configure every channel's the group address allocation, command calling details, scene configuration and other data of the devices.

Number: Each function's serial number (automatic sorting)

Function: Assigned the only non empty marking to the function;

Data Type: Functional data type including 1Bit, 1Byte, when choose 1Bit, the parameters of [Value=1] and [Value=0] effective, When choose 1Byte, calling all command of the channel by using scene recall.

Value=1: Setting the data type is 1Bit case, device receives the command which was called by the specified message value 1;

Value=0: Setting the data format is 1Bit case, device receives the command which was called by the specified message value 0;

Description: The described information of the function;

The Save button: The function of save the current editor

4.5 The download window

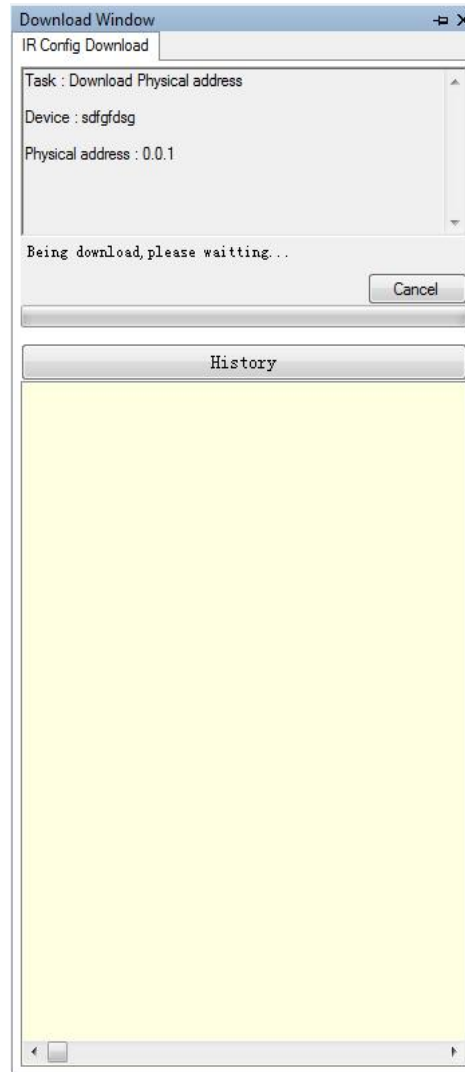
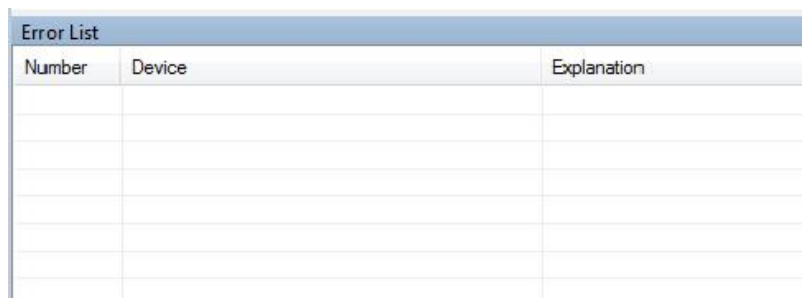

Fig.4.11 the download window

Choose the main menu bar [view] menu group drop-down menu [Download], pop up as shown in Figure 4.11 the download window when it is executing the download tasks. It can receive and perform the download task of other window, and each can only perform a download task. Users can cancel the current task's execution and view the information and schedule of the current task and task record By downloading Windows .

4.6 Error list

Select the main menu bar [view] menu group drop-down menu [Error list], Pops up as shown in Figure 4.12 The error list window. The function of error window is that receive and display the error configured information from other configuration window, and according to the error information to jump to the wrong collocation.



Error List		
Number	Device	Explanation

Fig.4.12 Error list

5. Demo

This chapter describes all the actual operation of the software function and the matters of needing attention.

5.1 Communication settings

Select [File][Communication][Connect the bus], and then Configure the downloader in the following dialog box, click on [OK].

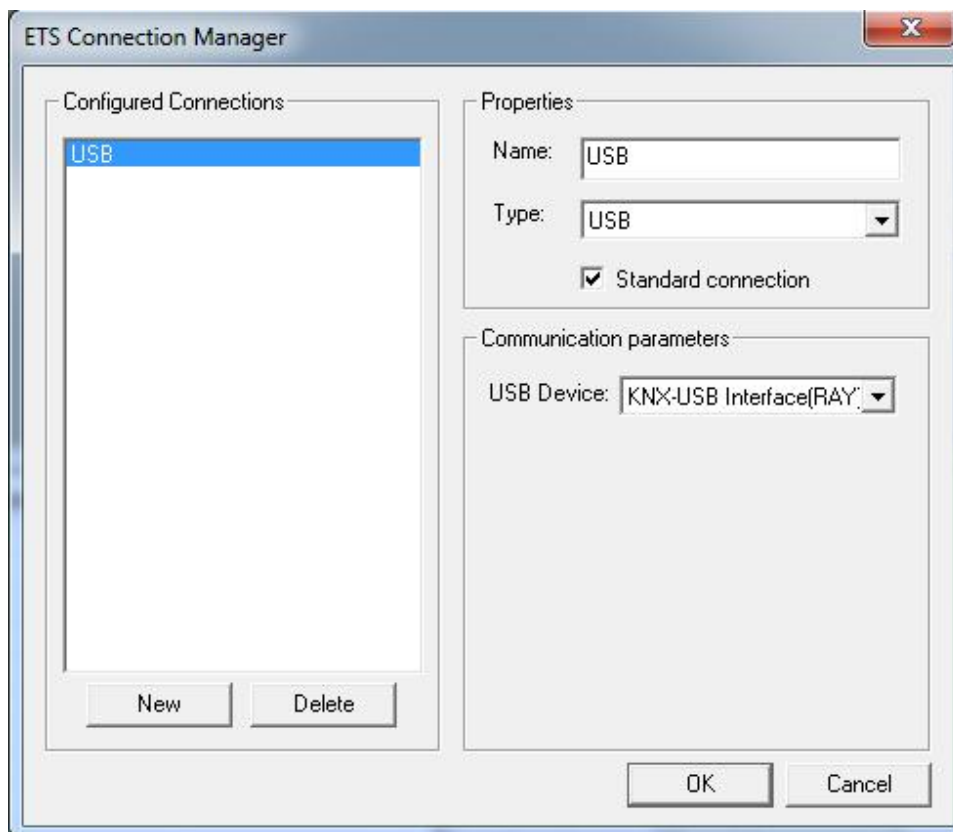

Note: If you select a USB connection in "Configure Connections" box, not detected download device in the right "Communication parameters" box, please check the connection of download device and PC machine. If the connection is well and the downloader is USB, we will need to install the driver.

5.2 IR configuration function

5.2.1 New Controlled appliance

(1) Right-Click the "IR learning code manager" ,In the shortcut menu,select [New Appliance],then set the appliance name in the following dialog box,click on [OK].

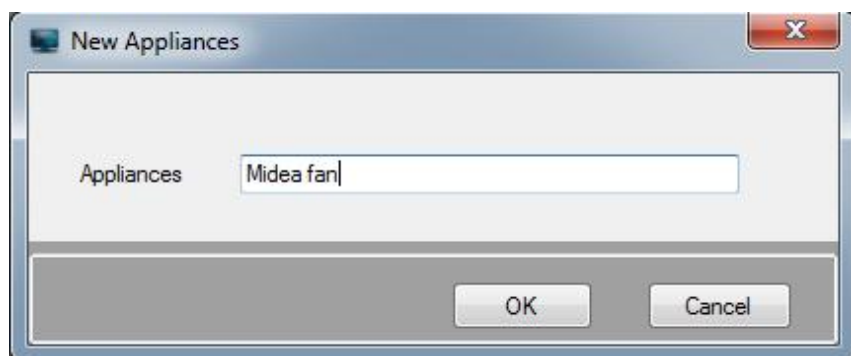

(2) Right-Click a appliance in IR learning code manager,In the shortcut menu,select [New function],Pop-up dialog box shown below.

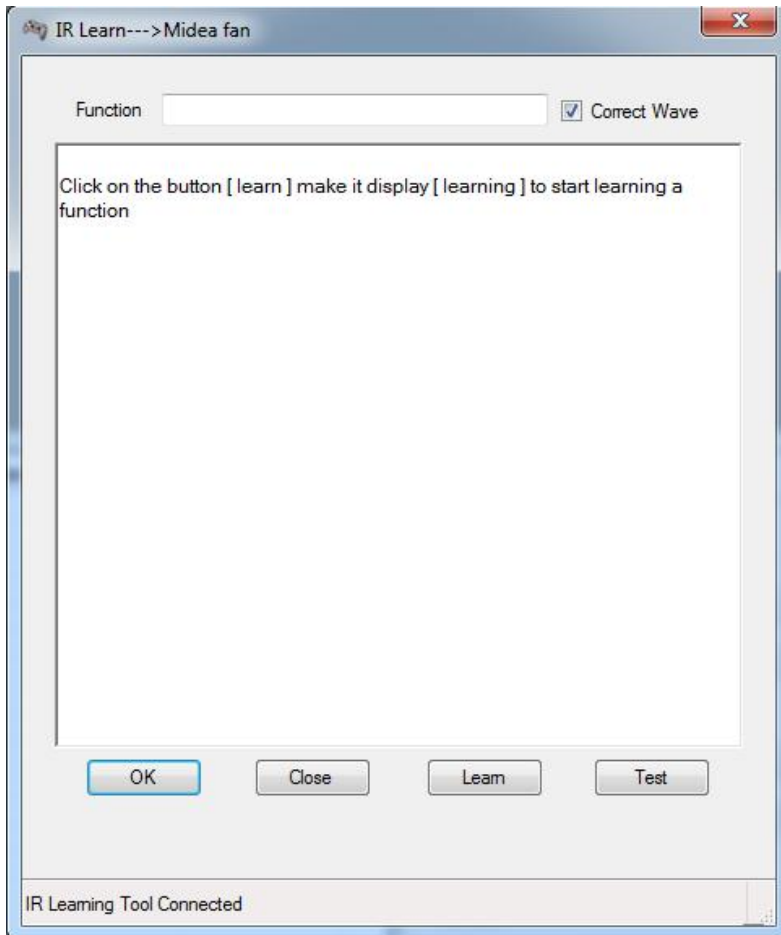

(3) Click on the button [learn] make it display [learning] ,identify the software entering to the learning state .Then place the Emitter head of remote controller on receives head of learner about 0.5cm~2cm show as following.

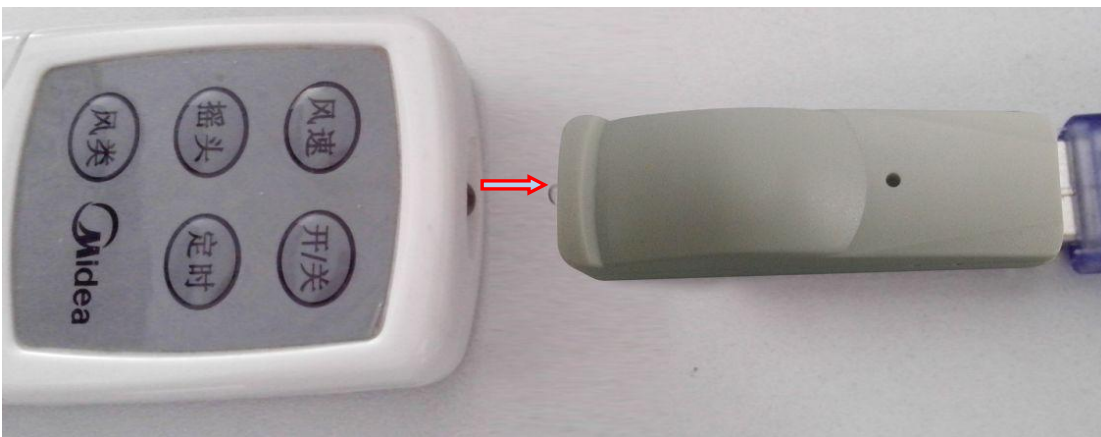

(4) Press the button on the remote control,When the IR learner receives the signal emitted by the remote control a button display the "learning" turn to "learn" to identify this study is completed,show as following .Then test the validity of this study.

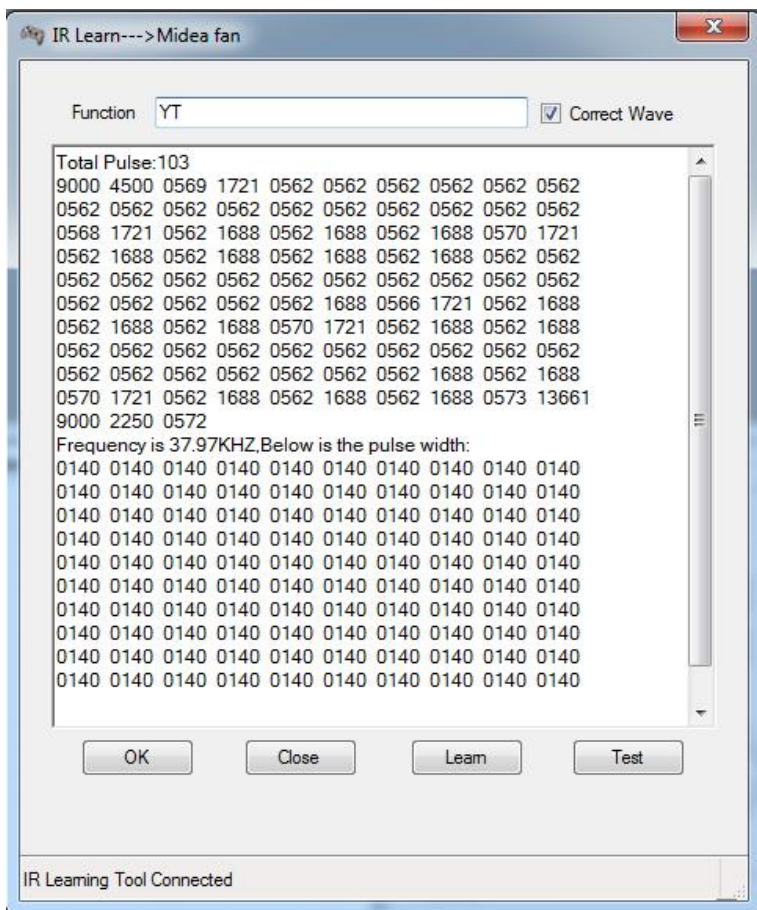

(5) Placed IR learner on the opposite of controlled electrical infrared receiver less than 4 meters , then click on the button "Test" to test this learning code,show as fowwing .If the test is valid,click button "OK" to save this encoding, If invalid, repeat steps (2)~(4).

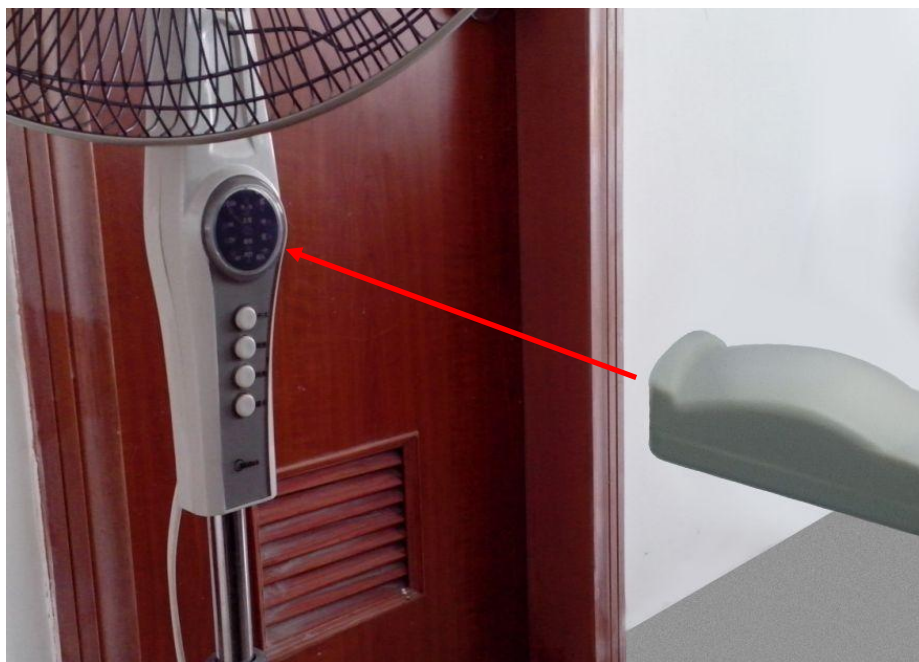

(6) Repeat(2)~(5) step to complete the learning of remote controller function.

5.2.2 New IR transmitter

(1) Right-Click the IR Device Manager,In the shortcut menu,select [New Decie].then set the device information in the following dialog box,click on [OK].



(2) Select a device in IR Device Manager,then select a appliance in the IR Learning Code Manager, and select a function of this appliance in the detailed list box. According to the needed to input various parameters, click button [Add command] to add the command to current device,show as following.

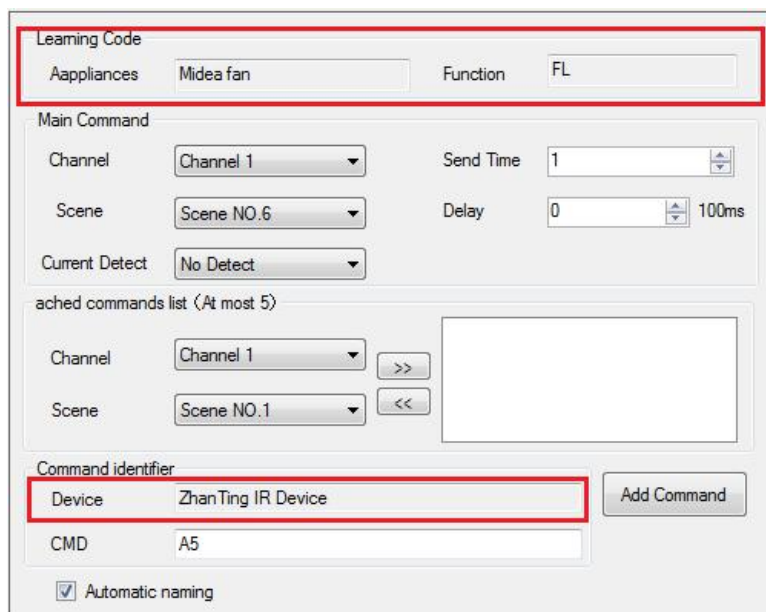

(3) Repeat (1)~(2) step to config the device command,Get commands show as following fig.

Number	CMD	Main Command Parameters			Attached CMD	Send Times	Delay(100ms)	Current Detect
		CMD Number	Appliances	Function				
1	A1	C1 / S1	Midea fan	KG		1	0	No Detect
2	A2	C1 / S2	Midea fan	FS		1	0	No Detect
3	A3	C1 / S3	Midea fan	YT		1	0	No Detect
4	A4	C1 / S4	Midea fan	DS		1	0	No Detect
5	A5	C1 / S5	Midea fan	FL		1	0	No Detect
6	A6	C1 / S6	Midea fan	KG	C1 / S3	1	3	No Detect
7	ON	C1 / S7	Midea fan	KG		1	0	No Current to send
8	OFF	C1 / S8	Midea fan	KG		1	0	Have Current to send
9	B1	C2 / S1	Midea fan	FS		1	0	No Detect
10	B2	C2 / S2	Midea fan	KG		1	0	No Detect
11	B3	C2 / S3	Midea fan	YT		1	3	No Detect
12	B4	C2 / S4	Midea fan	DS		1	3	No Detect
13	B5	C2 / S5	Midea fan	FL		1	0	No Detect
14	B6	C2 / S6	Midea fan	KG	C2 / S3	1	3	No Detect

(4) We have configed some command for the current device the last time ,then we will call these command to config a device function,Configuration show as follows Fig:

① Configuration of channel A:

Number	Function	GroupAddress	Data Type	Value=1	Value=0	Describe	
1	ScenA	1/0/0	1Byte	Any Command	Any Command		Saved
2	KG/FS	1/0/1	1Bit	A1	A2		Saved
3	YT/DS	1/0/2	1Bit	A3	A4		Saved
4	FL/KG	1/0/3	1Bit	B5	B2		Saved
5	YT	1/0/4	1Bit	A3	A3		Saved
6	ON/OFF	1/0/5	1Bit	ON	OFF		Saved
7	Absolute	1/0/6	4Bit	A2	A3		Saved

② Configuration of channel B:

Number	Function	GroupAddress	Data Type	Value=1	Value=0	Description	
1	ScenB	2/0/0	1Byte	Any Command	Any Command		Saved
2	FS/KG	2/0/1	1Bit	B1	B2		Saved
3	YT	2/0/2	1Bit	B3	B3		Saved
4	KG Attached	2/0/3	1Bit	B6	B6		Saved
5	Com	1/0/1	1Bit	B4	A2		Saved

③ Configuration of channel C:

Number	Function	GroupAddress	Data Type	Value=1	Value=0	Description	
1	ScenC	3/0/0	1Byte	Any Command	Any Command		Saved
2	DS/FS	1/0/1	1Bit	A4	B1		Saved

④ Configuration of channel D: No configuration

The Group configuration analysis as follows table:

Telegram			The response process of IR Emitter			
Group Address	Data Format	Value	Chanel A	Chanel B	Chanel C	Chanel D
1/0/0	Byte	0	C1/S1			
1/0/0	Byte	1	C1/S2			
1/0/0	Byte	2	C1/S3			
1/0/0	Byte	...	C1/S...			
1/0/0	Byte	x	C1/S(1+x)			
1/0/1	1Bit	1	A1	B4	A4	
1/0/1	1Bit	0	A2	A2	B1	
1/0/2	1Bit	1	A3			
1/0/2	1Bit	0	A4			
1/0/3	1Bit	1	B5			
1/0/3	1Bit	0	B2			
1/0/4	1Bit	1	A3			
1/0/4	1Bit	0	A3			
1/0/5	1Bit	1	ON			
1/0/5	1Bit	0	OFF			
2/0/0	Byte	1		C2/S2		
2/0/0	Byte	2		C2/S3		
2/0/0	Byte	...		C2/S...		
2/0/0	Byte	x		C2/S(1+x)		
2/0/1	1Bit	1		B1		
2/0/1	1Bit	0		B2		
2/0/2	1Bit	1		B3		
2/0/2	1Bit	0		B3		
2/0/3	1Bit	1		B6		
2/0/3	1Bit	0		B6		
3/0/0	Byte	0			C3/S1	
3/0/0	Byte	1			C3/S2	
3/0/0	Byte	2			C3/S3	
3/0/0	Byte	...			C3/S...	
3/0/0	Byte	x			C3/S(1+x)	

5.2.3 Error correction

In the configuration process, we often have to create, delete, modify some commands, and these operations may affect the group configuration function. For example, the command "A6" have been some function calls in channel A, if you delete it that will show the error as following Fig .Double click the error term, jump to the point of error ,then modification.If not timely amended, will lead to the same mistake at the download data validation and cannot download.

Error List		
Number	Device	Explanation
1	ZhanTing IR Device	In [Channel A],the command[Value=1] of function [YT/DS] is deleted
2	ZhanTing IR Device	In [Channel A],the command[Value=1] of function [YT] is deleted
3	ZhanTing IR Device	In [Channel A],the command[Value=0] of function [YT] is deleted
4	ZhanTing IR Device	In device command{ A6 },the attached command number [C1 / S3] is deleted

5.2.4 Download

In the previous subsection, we have provided a simple infrared transmitter devices, this section describes how to download configuration to the IR Emitter via the KNX bus, the example of download all as follow:Right-Click a device,In the shortcut menu,select [Download][All].You must to press the programming button before downloading physical address or downloading all.

5.2.5 Debug

Right-Click a device,in the shortcut menu,select [Debug] jump to the debug window.then you can send the write or read telegram to test you device.

5.2.6 Import\Export IR learning encoding data

After create electrical appliances, in order to backup data, we can Export encoding data to the file ".IRCode".or import encoding data of file ".IRCode" or ".IRConfig" .

(1) Export file ".IRCode"

Right-Click a appliance,in the shortcut menu,select [Export],then export the encoding of appliance.Show as flow fig.(You can also Right click the IR Learning Code Manager to export all appliances).

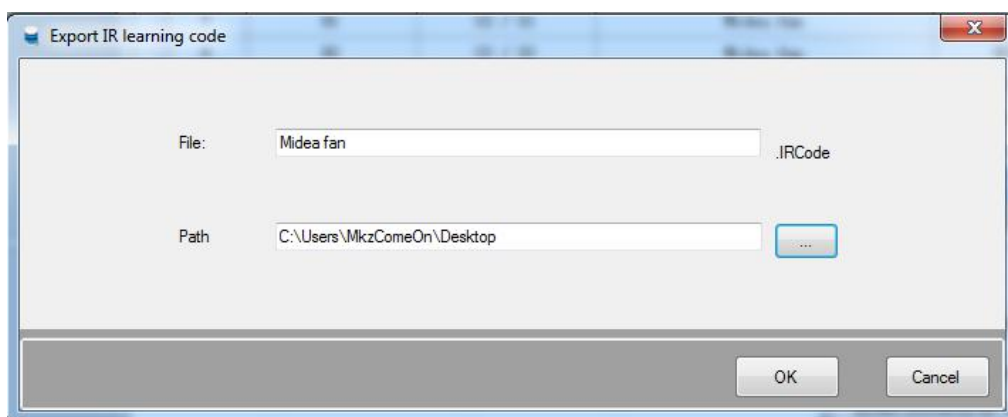

(2) Import file ".IRCode" or ".IRConfig"

Right-Click the IR Learning Code Manager, in the shortcut menu, select [Import] to import all encoding data of the file ".IRCode" or ".IRConfig". In the Dialog, click button [...] to select the file, then click [OK].

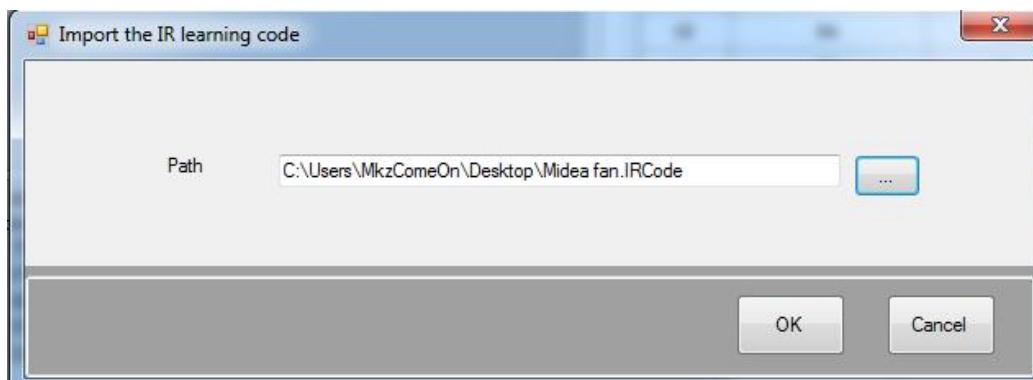

5.3 Security settings

5.3.1 Encryption

In the main menu,select [File][Security settings][Encryption],show as follow Dialog.

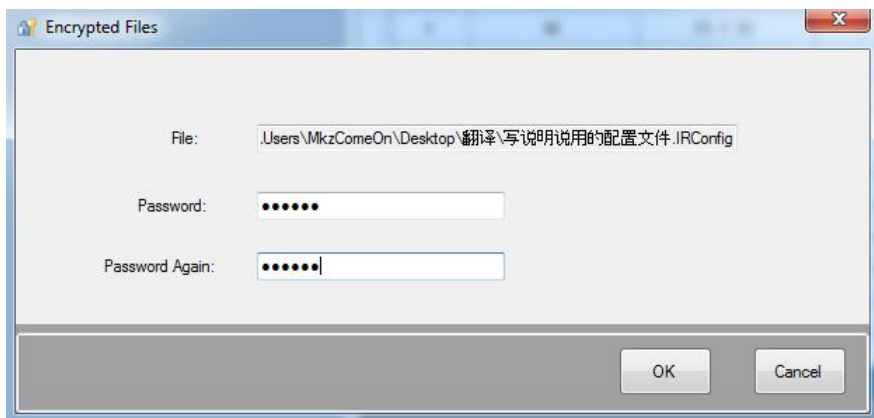

5.3.2 Change Password

In the main menu,select [File][Security settings][Change password],show as follow Dialog.

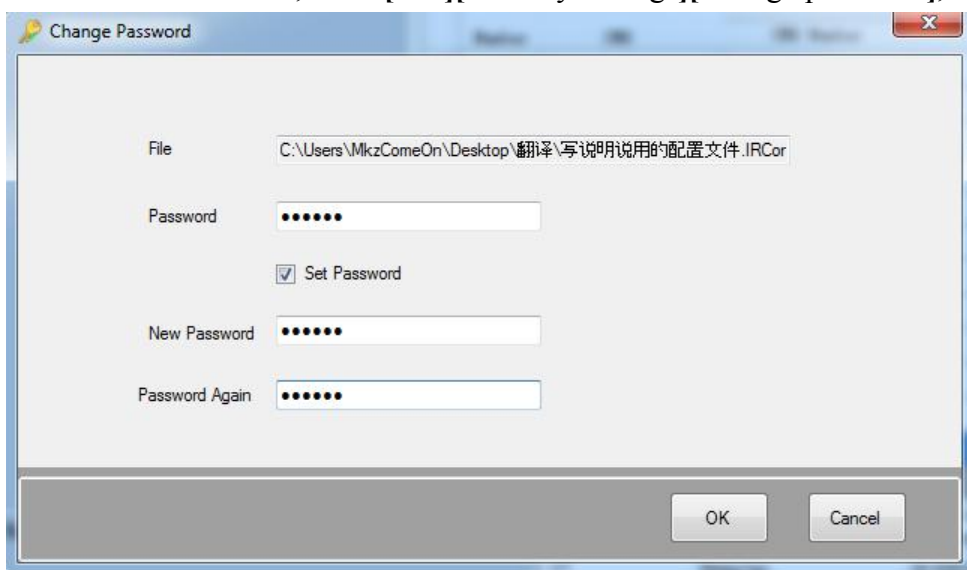

5.4 The language switching

In the software operation, Select [语言(Language)][Simplified Chinese]or[English], then Restart the software. Note:Only to restart software, language changing take effect.

5.5 Precautions

- ①The stored path of configuration file should not be too long, the total path characters cannot exceed 255 characters;
- ②The configuration file name cannot exceed 255 characters;
- ③Object (such as device, appliances, device command) name cannot exceed 255 characters;
- ④If the device command sending times more than 2 times or also as other attached commands ,Suggest to add some delay, otherwise the controlled electric appliance will respond not to come over;
- ⑤The file cannot be deleted when opened, otherwise the software will pop-up anomaly with cannot find the file;
- ⑥".IRCode" and ".IRConfig" files can only be opened with the software,otherwise it will damage the file;
- ⑦File encryption to protect the file only in a certain extent, so the important data must to be make a backup;
- ⑧This software does not provide the password retake service , so be sure to remember file password;
- ⑨The red box files are software system files,missing software will not run.



Note: The red box files are software system files.The file "en" is English language pack, missing English interface cannot be used.

6. Appendix 1 Device Command execution process

The orders of the principal and subordinate command are determined by the delay of command preferentially when executing command. If there is no difference in delay, then the principal command is before the subordinate command while the subordinate command determined by the position sequence of "Attached CMD". And the command does't support the recursive call—that is the subordinate command of command can not be executed. Here are some examples below that will introduce the process in detail.

(1) Part in common for principal and subordinate command

Number	CMD	Main Command Parameters			Attached CMD	Send Times	Delay(100ms)	Current Detect
		CMD Number	Appliances	Function				
1	D	C1 / S5	Midea fan	RG	C1 / S10 , C1 / S8 , C1 / S6 , C1 / S9 , C1 / S7	1	10	No Detect
2	A	C1 / S6	Midea fan	DS		1	20	No Detect
3	B	C1 / S7	Midea fan	FS		4	0	No Detect
4	C	C1 / S8	Midea fan	YT		1	20	No Detect
5	E	C1 / S9	Midea fan	FL		4	10	No Detect
6	F	C1 / S10	Midea fan	CQ		2	0	No Detect

In the chart, C1/S5 corresponding to D, C1/S6 corresponding to A, C1/S7 corresponding to B, C1/S8 corresponding to C, C1/S9 corresponding to E, C1/S10 corresponding to F.

When the emitter calls command D, we can get the sequence from the delay time preferentially: (B、F)<(D、E)<(A、C); the orders of those have the same delay time are based on the the position sequence of "Attached CMD". Then we can get the final sequence: F(2)-B(4)-D(1)-E(4)-A(1)-C(1) and the execution time $N=2+4+1+4+1+1=13$.

The system schematic diagram as follow(will not mention below): when the command begins, the time -counter variate Time start to change(added by 1 in every 100ms) as well as the total execution time N(decreaced by 1).

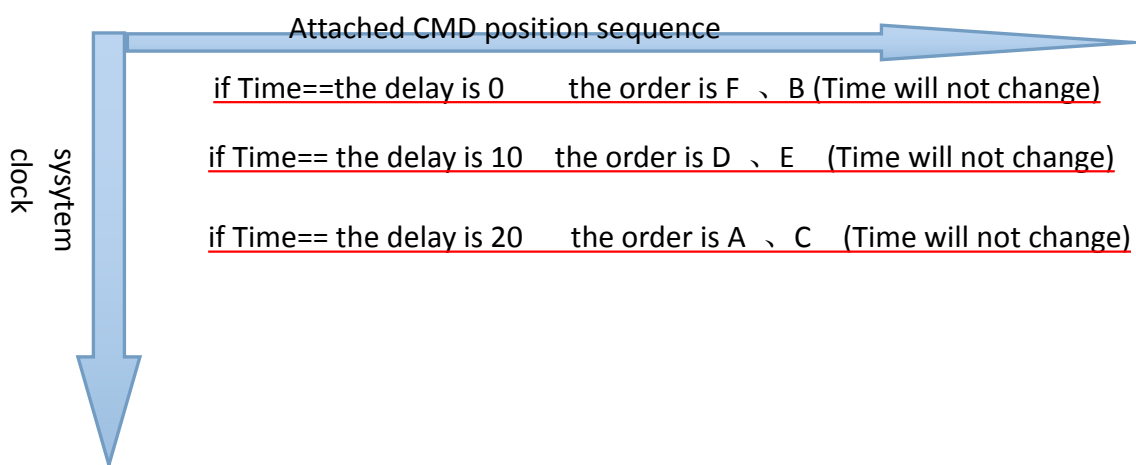

(2) Totally Different delay time for principal and subordinate command

①When the emitter calls command D, the ascending order according to the delay time is $A < B < D < C$. Then we can send the commands in sequence: A(1)-B(1)-D(1)-C(1), in which the numbers in the brackets represent the execution time.

Number	CMD	Main Command Parameters			Attached CMD	Send Times	Delay(100ms)	Current Detect
		CMD Number	Appliances	Function				
1	D	C1 / S5	Midea fan	KG	C1 / S6 , C1 / S7 , C1 / S8	1	20	No Detect
2	A	C1 / S6	Midea fan	DS		1	0	No Detect
3	B	C1 / S7	Midea fan	FS		1	10	No Detect
4	C	C1 / S8	Midea fan	YT		1	30	No Detect
5	E	C1 / S9	Midea fan	FL		1	0	No Detect

②When the emitter calls command D, the ascending order according to the delay time is $A < B < D < C$. Then we can send the commands in sequence: A(1)-B(5)-D(3)-C(1), in which the numbers in the brackets represent the execution time.

Number	CMD	Main Command Parameters			Attached CMD	Send Times	Delay(100ms)	Current Detect
		CMD Number	Appliances	Function				
1	D	C1 / S5	Midea fan	KG	C1 / S6 , C1 / S7 , C1 / S8	3	20	No Detect
2	A	C1 / S6	Midea fan	DS		1	0	No Detect
3	B	C1 / S7	Midea fan	FS		5	10	No Detect
4	C	C1 / S8	Midea fan	YT		1	30	No Detect
5	E	C1 / S9	Midea fan	FL		1	0	No Detect

(3) No difference in delay time for principal and subordinate command

①When the emitter calls command D, the commands can not be ranked according to the delay time. Then the principal command D will be executed preferentially. Besides, the sequence of the subordinate commands are determined by the position sequence of "Attached CMD"—that is A、B、C、E、F. Finally, we can send the commands in sequence: D(1)-A(1)-B(1)-C(1)-E(1)-F(1), in which the numbers in the brackets represent the execution time.

Number	CMD	Main Command Parameters			Attached CMD	Send Times	Delay(100ms)	Current Detect
		CMD Number	Appliances	Function				
1	D	C1 / S5	Midea fan	KG	C1 / S6 , C1 / S7 , C1 / S8 , C1 / S9 , C1 / S10	1	0	No Detect
2	A	C1 / S6	Midea fan	DS		1	0	No Detect
3	B	C1 / S7	Midea fan	FS		1	0	No Detect
4	C	C1 / S8	Midea fan	YT		1	0	No Detect
5	E	C1 / S9	Midea fan	FL		1	0	No Detect
6	F	C1 / S10	Midea fan	CQ		1	0	No Detect

②When the emitter calls command D, the commands can not be ranked according to the delay time. Then the principal command D will be executed preferentially. Besides, the sequence of the subordinate commands are determined by the position sequence of "Attached CMD"—that is F、C、A、E、B. Finally, we can send the commands in sequence: D(1)-F(2)-C(1)-A(1)-E(4)-B(4), in

which the numbers in the brackets represent the execution time.

Number	CMD	Main Command Parameters			Attached CMD	Send Times	Delay(100ms)	Current Detect
		CMD Number	Appliances	Function				
1	D	C1 / S5	Midea fan	KG	C1 / S10 , C1 / S8 , C1 / S6 , C1 / S9 , C1 / S7	1	0	No Detect
2	A	C1 / S6	Midea fan	DS		1	0	No Detect
3	B	C1 / S7	Midea fan	FS		4	0	No Detect
4	C	C1 / S8	Midea fan	YT		1	0	No Detect
5	E	C1 / S9	Midea fan	FL		4	0	No Detect
▶ 6	F	C1 / S10	Midea fan	CQ		2	0	No Detect

7. Appendix 2 The response process of IR Emitter receiving the group telegram

The IR Emitter according to the data type and the group telegram value call related commands after receiving a correct group telegram(see 4.2.2 section),Here are some examples below that will introduce the process in detail. (Note: In order to understand of the appendix two, please read the appendix first).

Example 1

Channel A

Number	Function	GroupAddress	Data Type	Value=1	Value=0	Describe	
▶ 1	GFSDGFDS	1/0/112	1Byte	Any Command	Any Command		Saved
2	GG	1/0/100	1Bit	D	D		Saved
3	SSS	1/0/100	1Bit	A	B		Saved
4	DSD	1/0/100	1Bit	C	C		Saved
5	SS	1/0/100	1Bit	F	C		Saved

Channel B

Number	Function	GroupAddress	Data Type	Value=1	Value=0	Description	
▶ 1	dddd	1/0/11	1Bit	B	E		Saved
2	afdfs	1/0/12	1Bit	C	A		Saved

Channel C

Number	Function	GroupAddress	Data Type	Value=1	Value=0	Description	
▶ 1	fasf	1/0/13	1Bit	C	E		Saved

Channel D

Number	Function	GroupAddress	Data Type	Value=1	Value=0	Description	
▶ 1	fasdf	1/0/14	1Bit	E	E		Saved

Device Command Library

Number	CMD	Main Command Parameters			Attached CMD	Send Times	Delay(100ms)	Current Detect
		CMD Number	Appliances	Function				
1	D	C1 / S5	Midea fan	KG	C1 / S10 , C1 / S8 , C1 / S6 , C1 / S9 , C1 / S7	1	10	No Detect
2	A	C1 / S6	Midea fan	DS		1	20	No Detect
3	B	C1 / S7	Midea fan	FS		4	0	No Detect
4	C	C1 / S8	Midea fan	YT		1	20	No Detect
5	E	C1 / S9	Midea fan	FL		4	10	No Detect
6	F	C1 / S10	Midea fan	CQ		2	0	No Detect

The response process of IR Transmitter receiving the group telegram[1/0/100 1bit value=1]:

When receiving the group telegram, all the current commands of Channel A:

D(GG)\A(SSS)\C(DSD)\F(SS)(Parenthesis corresponding to the group configuration function),do the following:

First,According to the position sequence(Ascending):

Delay time 0: F(SS)

Delay time 10: D(GG)

Delay time 20: C(DSD)\A(SSS)

Second,According to the position in channel configuration sequence (From top to bottom):

①D(GG)

②A(SSS)

③C(DSD)

④F(SS)

Third,Based on the results of the last step,sort their Attached CMD according to the delay time:

①Attached CMD of D(GG):

(B[D(GG)]F[D(GG)])<E[D(GG)]<(A[D(GG)]C[D(GG)])

Delay time 0: B[D(GG)]F[D(GG)]

Delay time 10: E[D(GG)]

Delay time 20: A[D(GG)]C[D(GG)],**Square brackets is the main CMD.**

②A(SSS): have no Attached CMD;

③C(DSD): have no Attached CMD;

④F(SS): have no Attached CMD;

Fourth,Based on the results of the last step,According to the position in Attached CMD sequence (From left to right):

①Attached CMD of D(GG):

F[D(GG)]<B[D(GG)]<E[D(GG)]<C[D(GG)]<A[D(GG)]

Delay time 0: F[D(GG)]<B[D(GG)]

Delay time 10: E[D(GG)]

Delay time 20: C[D(GG)]<A[D(GG)]

②A(SSS): have no Attached CMD;

③C(DSD): have no Attached CMD;

④F(SS): have no Attached CMD;

Fifth,Insert the results of the last step into the results of the first step(From left to right and From top to bottom),Finally, we can get the results as follows:

When the IR Transmitter receiving the group telegram[1/0/100 1bit value=1],the channelA send the commands in sequence:

Alfter 0*100ms:

F(SS)\F[D(GG)]\B[D(GG)]

Alfter 10*100ms:

D(GG)\E[D(GG)]

Alfter 20*100ms:

C(DSD)\A(SSS)\C[D(GG)]\A[D(GG)]

For ease of observation(The sending times of each command see in the device library):

Alfter 0*100ms:

F\F\B

Alfter 10*100ms:

D\E

Alfter 20*100ms:

C\A\C\A

Example 2

Channel A

Number	Function	GroupAddress	Data Type	Value=1	Value=0	Describe	
1	GFSDGFDS	1/0/112	1Byte	Any Command	Any Command		Saved
2	GG	1/0/100	1Bit	D	D		Saved
3	SSS	1/0/100	1Bit	A	B		Saved
4	DSD	1/0/100	1Bit	C	C		Saved
5	SS	1/0/100	1Bit	F	C		Saved

Channel B

Number	Function	GroupAddress	Data Type	Value=1	Value=0	Description	
1	dddd	1/0/11	1Bit	B	E		Saved
2	afdfs	1/0/12	1Bit	C	A		Saved

Channel C

Number	Function	GroupAddress	Data Type	Value=1	Value=0	Description	
1	fasf	1/0/13	1Bit	C	E		Saved

Channel D

Number	Function	GroupAddress	Data Type	Value=1	Value=0	Description	
1	fasdf	1/0/14	1Bit	E	E		Save

Device Command Library

Number	CMD	Main Command Parameters			Attached CMD	Send Times	Delay(100ms)	Current Detect
		CMD Number	Appliances	Function				
1	D	C1 / S5	Midea fan	KG	C1 / S10 , C1 / S8 , C1 / S6 , C1 / S9 , C1 / S7	1	10	No Detect
2	A	C1 / S6	Midea fan	DS	C1 / S9 , C1 / S8 , C1 / S5 , C1 / S10	1	20	No Detect
3	B	C1 / S7	Midea fan	FS	C1 / S5 , C1 / S9 , C1 / S6	4	0	No Detect
4	C	C1 / S8	Midea fan	YT	C1 / S7 , C1 / S10 , C1 / S5 , C1 / S9 , C1 / S6	1	20	No Detect
5	E	C1 / S9	Midea fan	FL	C1 / S5 , C1 / S7	4	10	No Detect
6	F	C1 / S10	Midea fan	CQ		2	0	No Detect

The response process of IR Transmitter receiving the group telegram[1/0/100 1bit value=1]:

When receiving the group telegram, all the currnt commands of Channel A:

D(GG)\A(SSS)\C(DSD)\F(SS)(Parenthesis corresponding to the group configuration function),do the following:

First,According to the position sequence(Ascending):

Delay time 0: F(SS)

Delay time 10: D(GG)

Delay time 20: C(DSD)\A(SSS)

Second,According to the position in channel configuration sequence (From top to bottom):

①D(GG)

②A(SSS)

③C(DSD)

④F(SS)

Third,Based on the results of the last step,sort their Attached CMD according to the delay time:

①Attached CMD of D(GG):

(B[D(GG)]\F[D(GG)]<E[D(GG)]<(A[D(GG)]\C[D(GG)]))

Delay time 0: B[D(GG)]\F[D(GG)]

Delay time 10: E[D(GG)]

Delay time 20: A[D(GG)]\C[D(GG)],Square brackets is the main CMD.

②Attached CMD of A(SSS):

F[A(SSS)]<(D[A(SSS)]\E[A(SSS)]<C[A(SSS)])

Delay time 0: F[A(SSS)]

Delay time 10: D[A(SSS)]\E[A(SSS)]

Delay time 20: C[A(SSS)]

③Attached CMD of C(DSD):

(B[C(DSD)]、F[C(DSD)])<(D[C(DSD)]\E[C(DSD)])<A[C(DSD)]

Delay time 0: B[C(DSD)]\F[C(DSD)]

Delay time 10: D[C(DSD)]\E[C(DSD)]

Delay time 20: A[C(DSD)]

④F(SS):have no Attached CMD;

Fourth,Based on the results of the last step,According to the position in Attached CMD sequence (From left to right):

①Attached CMD of D(GG):

F[D(GG)]<B[D(GG)]<E[D(GG)]<C[D(GG)]<A[D(GG)]

Delay time 0: F[D(GG)]<B[D(GG)]

Delay time 10: E[D(GG)]

Delay time 20: C[D(GG)]<A[D(GG)]

②Attached CMD of A(SSS):

F[A(SSS)]<E[A(SSS)]<D[A(SSS)]<C[A(SSS)]

Delay time 0: F[A(SSS)]

Delay time 10: E[A(SSS)]<D[A(SSS)]

Delay time 20: C[A(SSS)]

③Attached CMD of C(DSD):

B[C(DSD)]<F[C(DSD)]<D[C(DSD)]<E[C(DSD)]<A[C(DSD)]

Delay time 0: B[C(DSD)]<F[C(DSD)]

Delay time 10: D[C(DSD)]<E[C(DSD)]

Delay time 20: A[C(DSD)]

④F(SS):have no Attached CMD;

Fifth,Insert the results of the last step into the results of the first step(From left to right and From top to bottom),Finally, we can get the results as follows:

When the IR Transmitter receiving the group telegram[1/0/100 1bit value=1],the channelA send the commands in sequence:

alfter 0*100ms:

F(SS)\F[D(GG)]\B[D(GG)]\F[A(SSS)]\B[C(DSD)]\F[C(DSD)]

alfter 10*100ms:

D(GG)\E[D(GG)]\E[A(SSS)]\D[A(SSS)]\D[C(DSD)]\E[C(DSD)]

alfter 20*100ms:

C(DSD)\A(SSS)\C[D(GG)]\A[D(GG)]\C[A(SSS)]\A[C(DSD)]

For ease of observation(The sending times of each command see in the device library):

alfter 0*100ms:

F、F、B、F、B、F

alfter 0*100ms:

D、E、E、D、D、E

alfter 0*100ms:

C、A、C、A、C、A